

OR-10-034 (RP-1017)

Demonstration of the Use of Multimedia Electronic Information Enhancements for a Chapter Handbook CD-ROM: 3D Modeling and Animation

Jeff Haberl, PhD, PE
Fellow ASHRAE

Ergun Akleman, PhD

This paper is based on findings resulting from ASHRAE Research Project RP-1017.

ABSTRACT

Earlier we demonstrated the effectiveness of multimedia and advanced presentation techniques such as 3D computer graphics, visualization and animation techniques (Akleman 2002). The previous paper was intended to serve as a model and guide for the broad use of these techniques in other ASHRAE publications. However, the 3D Models and Animations that were developed for ASHRAE publications has a unique set of problems that are different from classical 3D modeling and animation problems. Our experience with this project convinced us that these models and animations cannot be created without close collaboration between ASHRAE engineers and animation specialists. Therefore, in this paper, we expand the discussion initiated in the first paper by presenting some of the unique sets of difficulties we have faced during the process using two case studies, modeling and animation, of: (1) Rolling Piston and (2) Twin Screw Compressors.

INTRODUCTION

Recently a set of enhancements to the ASHRAE Handbook (ASHRAE 96) were presented. These enhancements demonstrated the effectiveness of multimedia and advanced presentation techniques such as 3D computer graphics, visualization and animation techniques (Akleman 2002). Using compressors as the subject, in the ASHRAE Research Project 1017-RP, we expanded on the traditional printed material contained in Chapter 34 of the 1996 HVAC Systems and Equipment Handbook. This demonstration currently serves as a model and guide for the broader use of these techniques in other ASHRAE publications. The enhanced chapter which is

contained in the CD-ROM version of the Handbook, is used to promote the effectiveness of improved presentation techniques, and the value of ASHRAE information resources.

Our earlier paper gives a general introduction to all the enhancements to the chapter. However, among these enhancements, 3D Modeling and Animation warrant a more careful examination because they create a special set of problems that require specific solutions with a collaboration between ASHRAE engineers and animation specialists. In this paper, we discuss the several causes of temporal aliasing problems and we present a unique set of difficulties we faced during the process using two case studies, namely modeling and animation of: (1) Rolling Piston and (2) Twin-Screw Compressors.

BACKGROUND: RECONSTRUCTION ERROR AND TEMPORAL ALIASING

The motion of many types of compressors is cyclical, i.e., compressors repeat the same motion again and again rapidly compressing small batches of gas (so fast it appears to be continuous). These cyclic motions are the result of the rotation of axially (or rotationally) symmetric objects which can be described as follows. Formally, an object \mathcal{O} is rotationally symmetric around the rotation axis n with rotation angle θ if $\mathcal{O} = \mathcal{R}_{n,\theta} \mathcal{O}$ where $\mathcal{R}_{n,\theta}$ is a rotational operator that rotates object \mathcal{O} around the rotation axis n .

The angle of rotational symmetry θ depends on the representation of the shape as well as the coloring and rotation axis. The basic shapes that have rotational symmetry are spheres, cylinders, toroidal shapes, and stars. Figure 1 shows how the shape of the object affects the rotational-symmetry angle.

Jeff Haberl is a professor in the Department of Architecture and an associate director of the Energy Systems Laboratory at Texas A&M University, College Station, TX. Ergun Akleman is a professor in the Department of Visualization in the College of Architecture at Texas A&M University, College Station, TX.

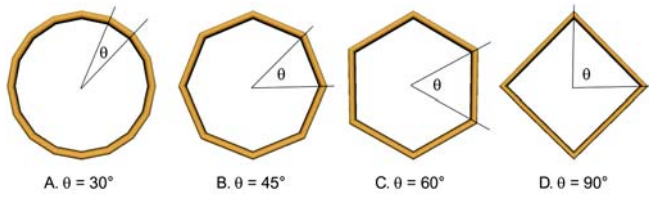

Figure 1 Shape versus rotational angle: An example that shows how the representation affects the rotational-symmetry angle.

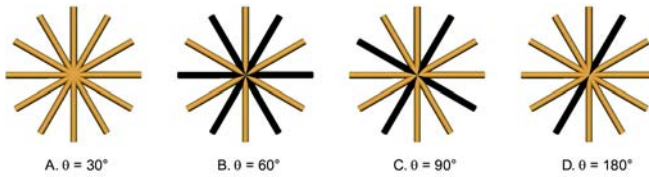

Figure 2 Color versus rotational angle: An example that shows how coloring of a shape changes the rotational symmetry.

Figure 2 shows how coloring of a shape can be used to change the rotational symmetry.

The rotational motion of a rotationally symmetric object \mathcal{O} can be given as $\mathcal{R}_{n,f(t)} \mathcal{O}$ where t is the time and $f(t)$ is a function of time. For the animation of the cyclical motions of compressors, without a loss of generality, $f(t)$ is simply a linear function given as

$$f(t) = \phi t, \quad (1)$$

where ϕ is a real number that define the “rotational speed” of the cyclical animation.

An animation is made up a time series of images, where each image is called a frame. Therefore, for analyzing animations the unit of t should be chosen to be “a frame.” The frame is not only the smallest, inseparable component of an animation, it is also is a virtual time step. The real speed, therefore, depends on how the animation is viewed. For instance, in classical animations 24 frames are projected each second. On the other hand, in most computer animations, 30 frames are shown each second. With the advent of the internet many animations are now being downloaded and viewed on a wide variety of computers. Unfortunately, in internet animations, the number of frames that are viewed per second directly depend on the speed of computer and internet connection. In other words, the frame becomes the only dependable time unit that is independent of how the animation is viewed. As a unit of the frame, t can take only integer values since we cannot have a fraction (such as half) of a frame.

Therefore, based on Equation (1), the period T of a rotational cyclic motion of a rotationally symmetric object with angle θ in terms of frames becomes

$$T = \theta/\phi \quad (2)$$

The relationship between θ and ϕ is critical in creating successful cyclic animations. The fundamental problem in cyclic animation is the creation of a motion that visually looks different from the intended motion. To avoid this problem (1) T must be an integer, and (2) T must be larger than 2.

The first condition is the direct result of using frames as time units. If T is not an integer, a “reconstruction error” occurs. The second condition is the result of the well-known “Nyquist criteria,” which simply states that to be able to recover a periodic function, we need to sample it at a rate that is twice the rate of the highest frequency component. If the second condition is not satisfied, a “temporal aliasing” error occurs. Anyone who has seen a western movie with a horse-drawn covered wagon has seen temporal aliasing whenever the spokes of the wagon wheel appear to be rotating backward even though the wagon is moving forward.

If T is an integer larger than 2, then the cyclic animation will simply consist of $N = T$ number of frames and the resulting animations will not have any reconstruction errors or temporal aliasing. If we ignore these two conditions, we will face a variety of problems. In the following subsections, we will present these problems for the cyclic motion of a rotationally symmetric object.

Reconstruction Error

If $T > 2$ but is not an integer, we will have a reconstruction error. In this case, we cannot use $N = T$ number of frames to create cyclic animation. If we choose the closest integer by rounding T as $N = \lfloor T + 0.5 \rfloor$, then there will be a change in the speed from the end to the beginning of the looping animation. The rotation angle from the last frame to the first frame is $\theta - (N - 1)\phi$. For instance, let $\theta = 30^\circ$; Table 1 shows the reconstruction error for different ϕ values. In this table, the absolute value of the difference between ϕ and the rotation angle from the last frame to the first frame corresponds to the reconstruction error. For a realistic animation, we want the value of the reconstruction error to be zero. If the value is not zero, the viewers will observe a sudden change in speed from the last frame to the first frame. As is shown in the table in Table 1, the sudden change in speed can be as much as 50% of the speed of animation.

The reconstruction error problem can be solved by identifying the minimum number of the frames that will give seamless cyclic animation. For seamless animation, the total rotation after N number of frames must be divisible by both θ and ϕ . In other words, the total rotation must be $lcm(\theta, \phi)$ where lcm is the least common multiplier of θ and ϕ . Based on this value, we can find that

$$N = \frac{lcm(\theta, \phi)}{\phi} \quad (3)$$

Table 1. Reconstruction Error versus θ , ϕ , T , N
The Table that Shows the Reconstruction Error for $\theta = 30^\circ$

θ	ϕ	T	N	Rotation Angle from the Last Frame to the First Frame	Recon- struction Error	Percentage Error
30	13	2.3	2	17	4	4/13=%31 faster
30	12	2.5	2	18	6	6/12=%50 faster
30	11	2.7	3	8	-3	3/11=527 slower
30	10	3.0	3	10	0	0/10=%0
30	9	3.3	3	12	3	3/9=%33 faster
30	8	3.7	4	6	2	2/8=%25 slower
30	7	4.3	4	9	2	2/7=%29 faster

Table 2. The Tables that Show How Many Frames are Needed to Avoid the Reconstruction Error for $\theta = 30^\circ$

θ	ϕ	$N = \frac{lcm(\theta, \phi)}{\phi}$
30	13	30
30	12	5
30	11	30
30	10	3
30	9	10
30	8	15
30	7	30

Unfortunately, the value of N fluctuates depending on ϕ values and can be very large for relatively-prime θ and ϕ values. An example is shown in the table in Table 2.

As seen in Table 2, making ϕ larger does not help to create a smaller animation file. Generally speaking, for ϕ , the best choice is $\phi = \theta/3$. This choice will create a cyclic animation using only three frames. In practice, we use more than three frames.

Temporal Aliasing

Temporal aliasing may cause the animated object to appear: (1) to rotate slower than the intended speed, (2) to rotate in the opposite direction of the intended motion, and (3) to stop. In order to identify these cases, we will first look at the relationship between ϕ and θ . Note that since the object is rotationally symmetric, if $\phi > \theta/2$, the viewer cannot perceive the real motion. For instance, if $\phi = n\theta$, where n is any integer, then the rotationally symmetric object will appear to be static; in each time step, the object will look exactly the same. The statement $\phi = n\theta$ can be rewritten as

$$\frac{\theta}{\phi} - \left\lfloor \frac{\theta}{\phi} \right\rfloor = \frac{1}{T} - \left\lfloor \frac{1}{T} \right\rfloor = F - \lfloor F \rfloor = 0 \quad (4)$$

where $\lfloor F \rfloor$ is the largest integer that is smaller than F and $F = 1/T$ is the intended frequency of the rotation. Equation (4) is useful to identify three distinct temporal aliasing cases.

Case 1: $1 < F$ and $F - \lfloor F \rfloor < 0.5$. In this case, the object appears to be rotating slower than intended.

Case 2: $F - \lfloor F \rfloor = 0$. In this case, the object appears to be static.

Case 3: $F - \lfloor F \rfloor > 0.5$. In this case, the object appears to be rotating in the opposite direction than the intended motion's direction.

More Than One Rotationally-Symmetric Object

In engineering applications, we often need complicated, rotationally symmetric objects that will be constructed as a combination of basic symmetric shapes. This can be described in the following way: if a rotationally symmetric object consists of N basic shapes, and each basic shape i has a rotational angle θ_i , the combined rotational angle of the constructed object θ equals $lcm(\theta_1, \theta_2, \dots, \theta_N)$ where lcm is the least common multiplier of $\theta_1, \theta_2, \dots, \theta_N$.

If a rotationally symmetric object consists of two basic shapes, such as those shown in Figures 1A and 2A, since in both cases $\theta = 30^\circ$, then the combined θ also becomes 30° . On the other hand, if we create a shape combining two basic shapes, such as those shown in Figures 1B and 2B, then the combined $\theta = lcm(45^\circ, 60^\circ) = 180^\circ$, which is much larger than either of the θ . If θ_i 's are relatively-prime, then the combined $\theta = \theta_1 \times \theta_2 \times \dots \times \theta_N$, which is a much larger number than the rotation angle of any one of the basic components. In such cases, to avoid reconstruction error, we need to have longer animations. The only solution in these cases is to slightly change the rotational symmetry of each component. We will discuss this solution in the following section.

CASE STUDIES

We consider two case studies: Rolling piston and twin-screw compressor animations.

Case 1: Rolling Piston Compressor

For rolling piston compressors, the figure provided in Chapter 34 (ASHRAE 1996) is shown in Figure 3. In Figure 3, it is not easy to understand how the piston is working just by looking at this figure. This is because most people fail to see the opposing rotation of the concentric pistons. To understand this motion, we first created a cardboard model of a rolling piston to show how the piston turns. We eventually figured out that the piston rolls in a counter-clockwise direction while the shaft is rotating clockwise. To animate this, we faced a number of problems which varied depending on whether we were creating a pre-computed animation or an interactive animation.

The basic questions were:

- How can we graphically display the piston motion?
- How can we graphically display the fluid motion?

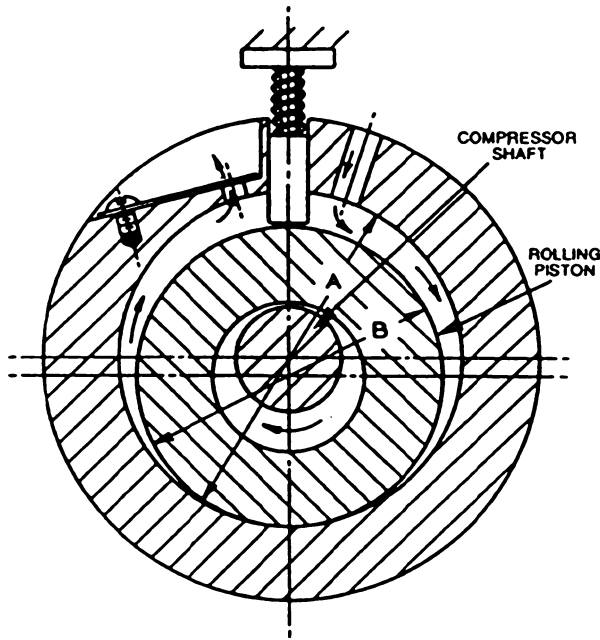

Figure 3 Rolling piston diagram.



Figure 4 A computer-generated model of a rolling piston with correct dimensions.

- How can we create a small size web-efficient animations?

We first created a computer model with correct dimensions as shown in Figure 4. One problem was that it left such a small space to display fluid motion. To resolve this problem

we enlarged the gap where the fluid flows. A more important problem was that it was impossible to create a small animation file using the correct dimensions. Since the size of the animation file directly depends on the period of cyclic animation, to reduce the size of the animation file, we made the period of the animation as small as possible while avoiding a reconstruction error. Unfortunately, based on the correct dimensions, the period of the cyclic animation turned out to be high.

The source of the problem was that there were two motions in the rolling piston animation (inner and outer circle-rotations), and the periods of these two motions were relatively prime. To resolve this, we noted that we can change θ and ϕ by changing the radius of the inner and outer circles. By playing the values of θ and ϕ , we were able to drastically reduce the size of the animation. Although the resulting model was not technically correct, the resulting animation worked faster, downloaded faster and gave a better idea about the motion of pistons in a rolling piston compressor. Selected frames of the resulting animation are shown in Figure 5.

Note that Figure 5 also shows flow animation. To improve the quality of the visualization of rolling piston compressors, we used a flow animation method developed earlier by Akleman (2000, 2002). Rolling piston compressors use a roller mounted on the eccentric axis of a shaft with a single vane or blade suitably positioned in the non-rotating cylindrical housing, generally called the cylinder block. This blade reciprocates in the slot machined in the cylinder block. This reciprocating motion is caused by the eccentricity of the moving roller directly below the blade that repeatedly lifts the blade. In order to create a rolling piston animation, we developed a simple texture-mapped 3D model for the compressor and animated the cylinders. We then rendered this animation using a parallel projection technique to include flow animation. The flow animation, which is used to give the illusion of the gas flow in the compression, was created separately. These two animations were then combined using a compositing program (Brinkman 1999).

Case 2: Twin-Screw Compressor

Due to their complex 3D motions, the working principles of twin-screw compressors need to be visualized with 3D perspective projection. The Chapter 34 figures related to these compressors were drawn using static perspective projection to show rotating and translating parts (ASHRAE 1996). Unfortunately, these static images provide little insight into how these parts move during the compression process. For instance, the figure provided in Chapter 34 for twin-screw compressors is shown in Figure 6. Unfortunately, it is not easy to understand the 3D structure of the compressor just by looking at this figure, and without an understanding of the exact 3D structure, it is difficult to understand how the compressor works.

Fortunately, we had a simple model of this particular compressor with a transparent casing that was obtained by a trade fair. Figure 7 shows a photograph of this simplified

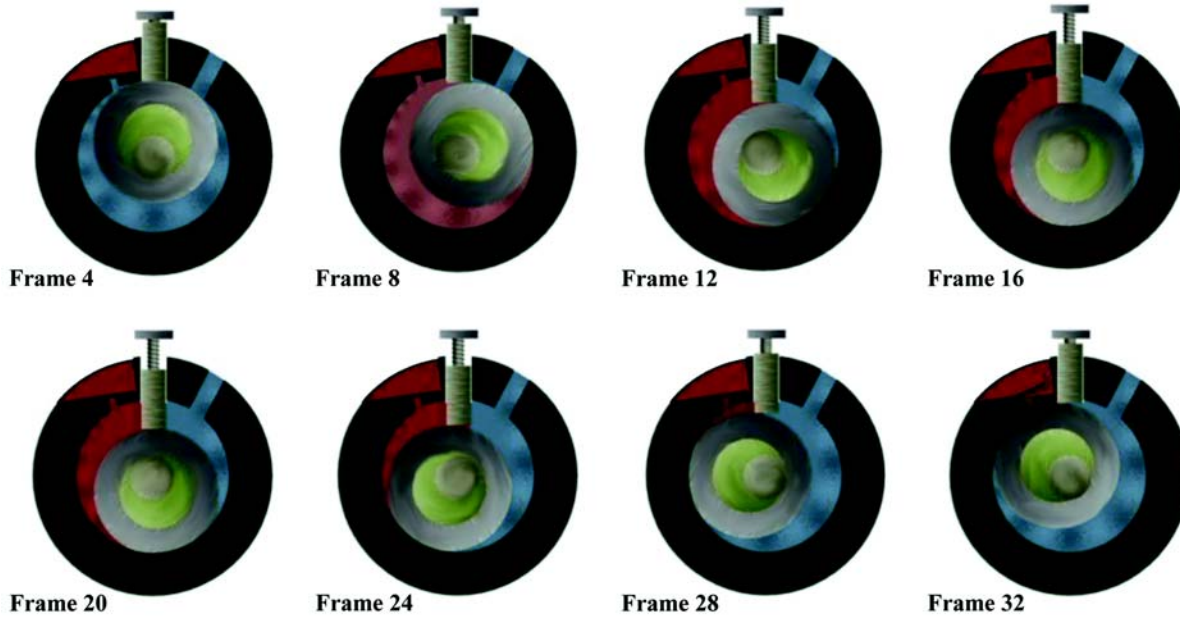

Figure 5 Selected (every 4th) frames of a rolling piston animation. The numbers below indicate the frame number. The whole animation consists of 32 frames. Note that the piston rolls clockwise.

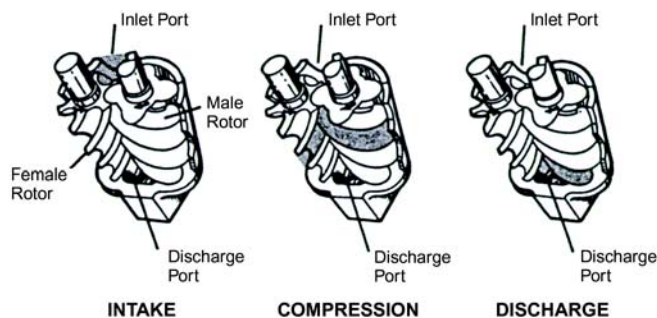

Figure 6 Twin-screw compressor.

model of a twin-screw compressor with a transparent casing. By viewing this model, we discovered that the number of the blades in the two screws were not the same. Another problem was understanding how the compressor worked. To understand the air motion, we dropped small candies into this model and observed how the candies travel through the twin screws. By tracing the individual candy motion, we eventually determined that the air did not rotate inside of the twin-screw chambers. Instead, we observed that each pocket of air followed a near linear path from the inlet to the outlet.

Note that to create engineering animations, it is sometimes unnecessary to use computer technology. In the ease of the transparent model of the twin-screw compressor, it was possible to use stop-motion animation of an existing 3D model. Figure 8 shows nine frames of stop-motion animation of a twin-screw compressor model.



Figure 7 A photograph of a simplified model of a twin-screw compressor in a transparent casing.

To represent these compressors with an animation, we first developed high-quality, three-dimensional computer models using a commercial software package (Boardman 2001). We then produced animations showing the dynamic operation of these compressors and the compressor components using photo-realistically rendered animation images. An example of a photo-realistically rendered 3D animation image frame is shown in Figure 9. These 3D image frames provide “picture-quality,” solid-looking dynamic representations of the critical

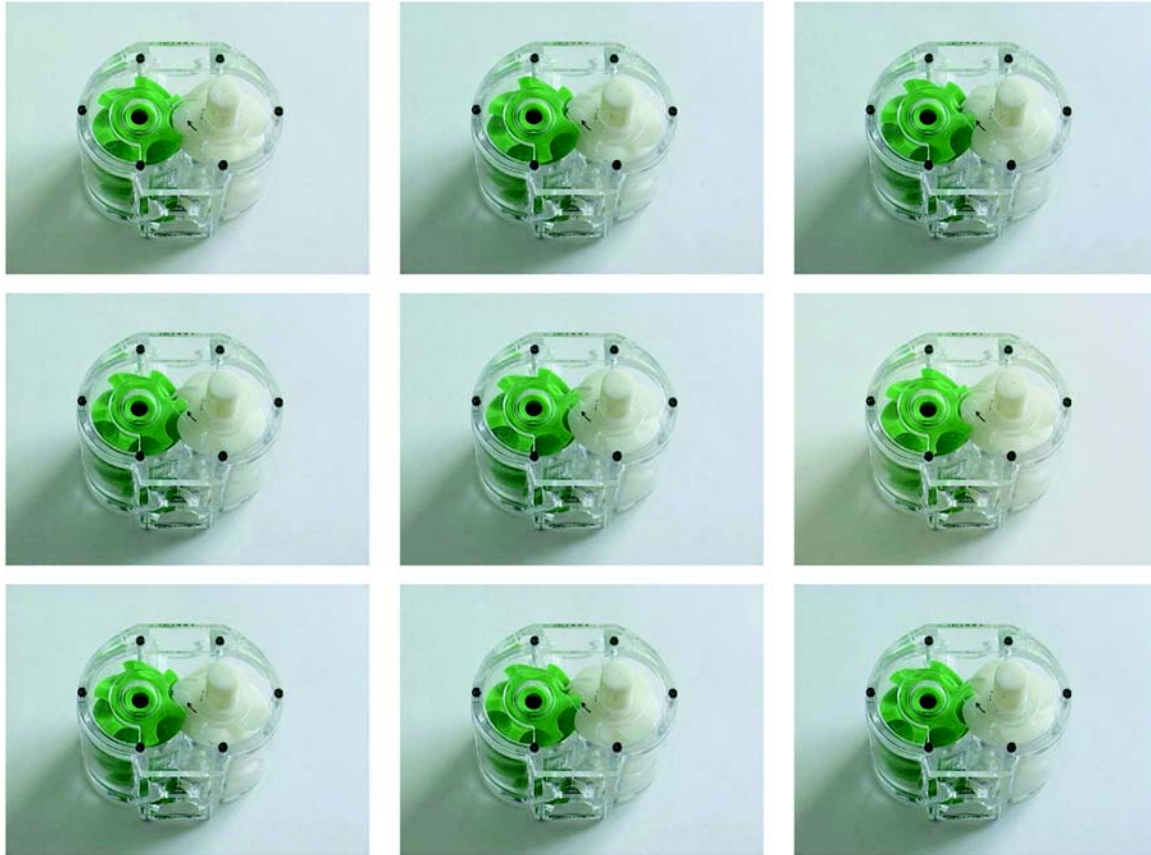

Figure 8 Nine frames of stop motion animation of a twin-screw compressor model.

components of each type of compressors. The animation then shows the dynamic operations of the components.

Unfortunately, in this case, we could not use the earlier flow animation method (Akleman 2000) since it can only produce a 2D flow animation. Instead, to represent the approximate path of the fluid flow, we used 3D arrows and ellipsoids. Actual 3D fluid flow characteristics were validated by observing the previously mentioned compressor operation. These three-dimensional animations were created in one of the popular viewing formats (Gulie 2000). Movie “viewers” for these files are included as an integrated part of the 1017-RP Demonstration CD-ROM. Figure 9 shows an image of the 3D animation.

CONCLUSION

ASHRAE Research Project 1017-RP has demonstrated the effectiveness of multimedia and advanced presentation techniques for the ASHRAE Handbook. This demonstration can serve as a model and guide for the broader use of these techniques in other ASHRAE publications. ASHRAE already published a copy of the 1017-RP final report CD-ROM, which includes a multimedia version of Chapter 34. This CD-ROM version of the enhanced chapter is already available from ASHRAE.

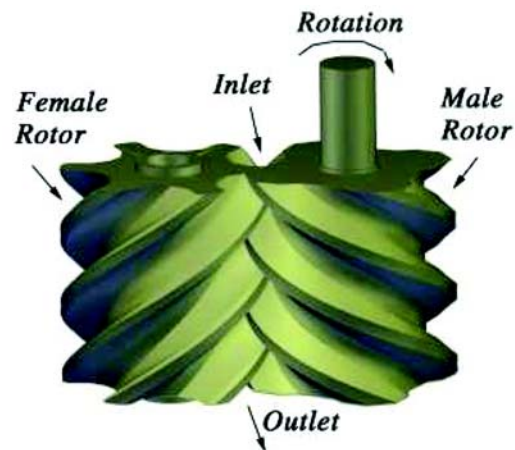

Figure 9 A frame from the twin screw animation.

One of the major goals for the future is the *cost-effective* conversion of the remaining chapters of the ASHRAE handbook into a similar multimedia representation. This goal can be accomplished by providing ASHRAE TC Handbook committee members with the tools and the knowledge they will need to create multimedia images.

ACKNOWLEDGMENTS

This work was supported by the American Society of Heating Refrigeration and Air Conditioning Engineers (ASHRAE) through research project 1017-RP. This project would not have been possible without the help of the ASHRAE PMSC members, including: J. Watts, A.D. Hallstrom, R.S. Briggs, D.J. Branson, M. Schwedler, B. Krafthefer, and D. Reid.

REFERENCES

- ASHRAE. 1996. *H.V.A.C. systems and equipment: Chapter 34—Compressors*. Atlanta: American Society of Heating, Refrigeration and Air-Conditioning Engineers.
- Brinkman, R. 1999. *The art and science of digital composting*. San Francisco: Morgan Kaufmann Publishers.
- Gulie, S.W. 2000. *Quicktime for the Web: Hands-on guide for webmasters, site designers, and html authors*. San Francisco: Morgan Kaufmann Publishers.
- Akleman, E., S. Skaria, and J.S. Haberl. 2002. Function based 2D flow animation. *Proceedings of the Visual 2000 Conference, Mexico City, Mexico*, pp. 149-152.
- Akleman, E., Z. Melek, and J.S. Haberl. 2001. Function based flow modeling and animation. *Journal of Visualization and Computer Animation* 12:181-189.
- Boardman, T. 2001. *3D studio max 4 fundamentals*. Indianapolis: Riders Publishing.
- Akleman, E., J.S. Haberl, F. Parke, and S. Skaria. 2002. Demonstration of the use of multimedia electronic information enhancements for a chapter handbook CD-ROM (1017 RP): Overview. *Proceedings of the ASHRAE 2002 Winter Meeting, Atlantic City, New Jersey*, January.

Copyright of ASHRAE Transactions is the property of American Society of Heating, Refrigerating and Air-Conditioning Engineers, Inc. and its content may not be copied or emailed to multiple sites or posted to a listserv without the copyright holder's express written permission. However, users may print, download, or email articles for individual use.